



---

MUSIC SOUNDS BETTER WITH US







# מתקני תליה ואביזרים לפרויקטים והתקנות קבע

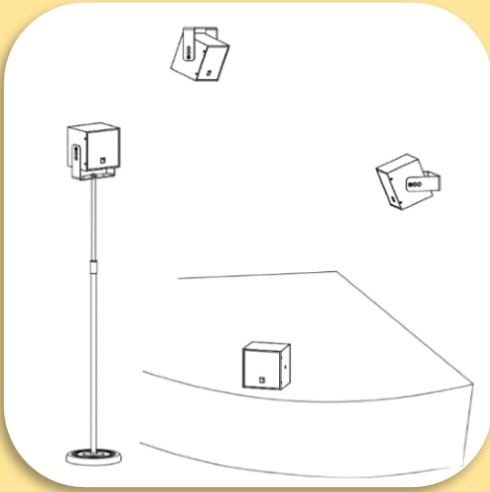











MADE IN FRANCE

# X SERIES





| תיאור  | תמונה  | סטנדים ואביזרים | דגם הרמקול |
|--|--|-----------------|------------|
| Adjustable U-bracket for X4i   |    | X-U4i           | X4i        |
| Base plate and bracket for X4i   |   | X-B4i           |            |
| Adjustable U-bracket: 5XT  |  | ETR5            | XT5        |
| Long U-bracket for X8  |  | X-UL8           | X8         |
| Long U-bracket for X8 - installation version (Not compatible with X-UTILT) |  | X-UL8i          |            |
| Short U-bracket for X8   |  | X-US8           |            |

|   |   |          |     |
|---|---|----------|-----|
| X-UTILT   |    | X-UTILT  |     |
| X-BAR   |     | X-BAR    |     |
| EMBi  |     | EMBi     |     |
| Long U-bracket for X12                                |     | X-UL12   | X12 |
| Short U-bracket for X12 and X15 HiQ                   |    | X-US1215 |     |
| U-bracket wallmount for X series with tilt adjustment |  | X-UTILT  |     |
| Rigging bar for 1 enclosure                           |   | X-BAR    |     |
| Pole mount socket: 8XTi/12XTi and X series            |   | EMBi     |     |
| Clamp certified for 250 kg                            |   | CLAMP250 |     |
| Long U-bracket for X15 HiQ                            |   | X-UL15   |     |

|  |   |          |  |
|--|---|----------|--|
| Short U-bracket for X12 and X15 HiQ        |   | X-US1215 |  |
| Short U-bracket for X12 and X15 HiQ        |  | X-UTILT  |  |
| Rigging bar for 1 enclosure                |   | X-BAR    |  |
| Pole mount socket: 8XTi/12XTi and X series |   | EMBi     |  |
| Clamp certified for 250 kg                 |  | CLAMP250 |  |

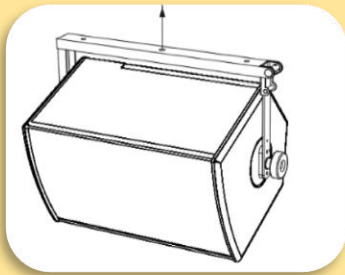
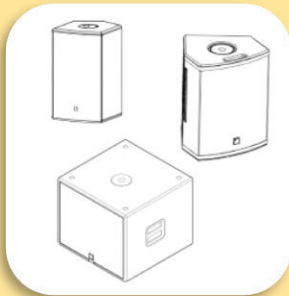
## P SERIES







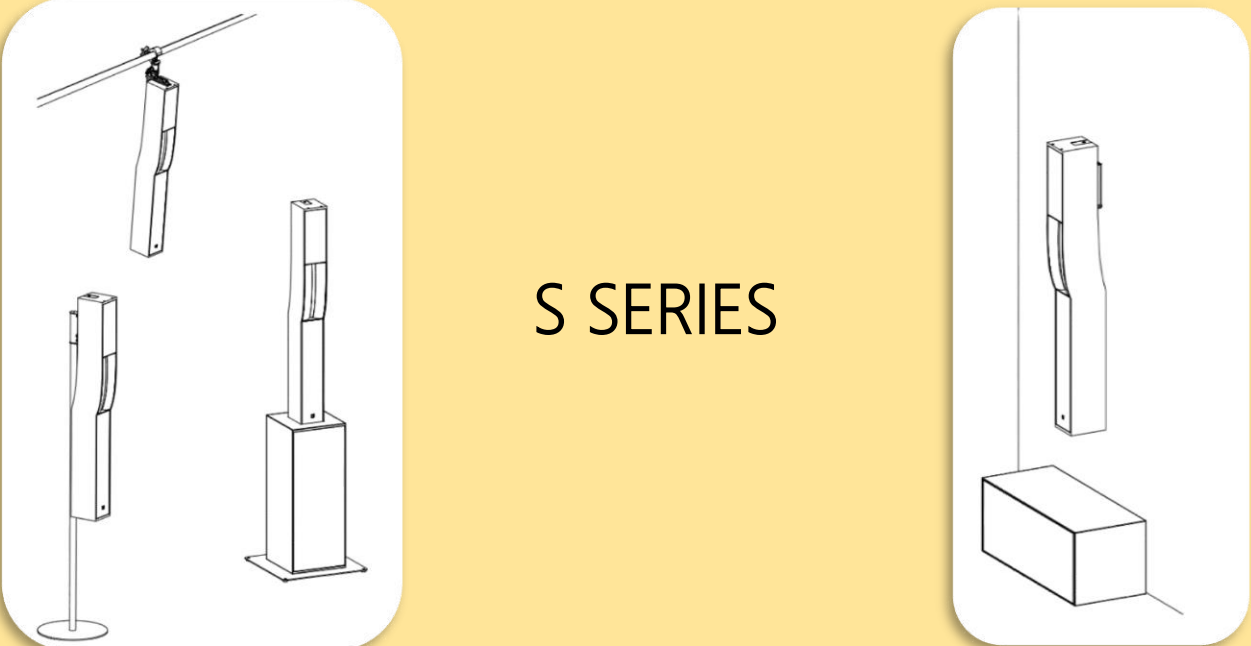

| תיאור                                  | תמונה  | סטנדים ואביזרים | דגם הרמקול |
|--|--|-----------------|------------|
| Adjustable U bracket: 8XT-108P-MTD108a |  | ETR8-2          | P108       |

|                                       |  |         |           |
|---------------------------------------|--|---------|-----------|
| Adjustable U bracket: 12XT-112P-112XT |  | ETR12-2 | P112      |
| Adjustable U bracket: SB15P           |  | ETR15P  | SB15<br>P |

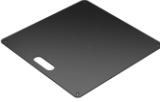

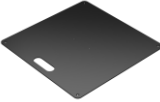
## S SERIES

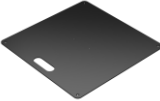





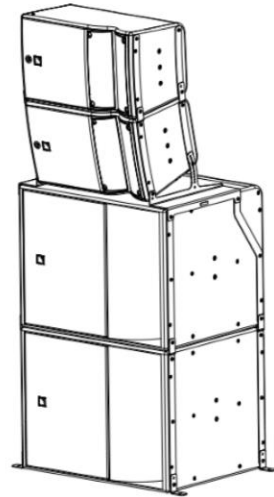
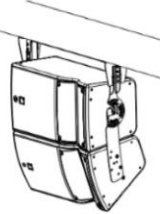
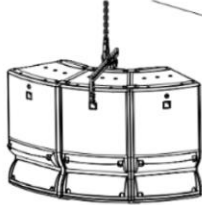
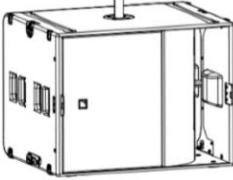
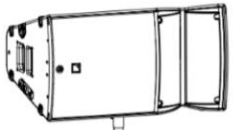

| תיאור                       | תמונה   | סטנדים ואביזרים | דגם הרמקול |
|-----------------------------|---|-----------------|------------|
| Wall-mount for Syva         |  | SYVA<br>WALL    | Syva       |
| Pole-mount adapter for Syva |   | SYVA<br>POLE    |            |
| Rigging bar for Syva        |   | SYVA BAR        |            |

|                                     |  |               |             |
|-------------------------------------|--|---------------|-------------|
| Baseplate for Syva system           |    | SYVA<br>BASE  |             |
| Clamp certified for 250 kg          |    | CLAMP25<br>0  |             |
| Protective cover for Syva enclosure |    | SYVA<br>COV   |             |
| Baseplate for Syva system           |   | SYVA<br>BASE  | Syva<br>Low |
| Protective cover for Syva enclosure |  | SYVALF<br>COV |             |
| Baseplate for Syva system           |  | SYVA<br>BASE  | Syva<br>Sub |
| Protective cover for Syva enclosure |  | SYVALF<br>COV |             |









# A SERIES



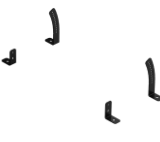

















| תיאור  | תמונה | סטנדים ואביזרים | דגם הרמקול             |
|--|-------|-----------------|------------------------|
| Flying frame for vertical deployment of A10        |       | A10-BUMP        | A10<br>Focus /<br>Wide |
| Rigging element for horizontal deployment of A10   |       | A10-LIFT        |                        |
| Rigging bar and pullback for A10                   |       | A10-RIGBAR      |                        |
| Pole mount for A15 and A10                         |       | A-MOUNT         |                        |
| Rigging element for stacking A15 and A10 onto KS21 |       | A-TILT          |                        |
| Rigging bar for 1 enclosure                        |       | X-BAR           |                        |

|   |  |                        |                   |
|---|--|------------------------|-------------------|
| Clamp certified for 250 kg  |    | CLAMP250               |                   |
| m chain sling with two-leg bridles rated 12 tons                            |    | LA-SLING2T             |                   |
| Magnetic plate for laser inclinometer (compatible with TEQSAS LAP-TEQ PLUS) |    | LASER-MAGPLATE         |                   |
| Acoustically transparent front screen for A10i Focus                        |    | A10i FOCUS-SCREEN      | A10i Focus / Wide |
| Acoustically transparent front screen for A10i Focus with A10i-LIFT         |   | A10i FOCUS-SCREEN-LIFT |                   |
| Acoustically transparent front screen for A10i Wide                         |  | A10i WIDE-SCREEN       |                   |
| Acoustically transparent front screen for A10i Wide with A10i-LIFT          |  | A10i WIDE-SCREEN-LIFT  |                   |
| Flying frame for vertical deployment of A10iW                               |  | A10i-BUMP              |                   |
| Rigging element for horizontal deployment of A10                            |  | A10i-LIFT              |                   |

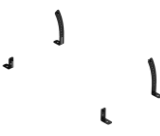

|   |  |                  |  |
|---|--|------------------|--|
| Rigging bar and pullback for A10i   |    | A10i-RIGBAR      |  |
| U-bracket for A10i  |    | A-U10i           |  |
| Rigging elements with angles for A10i onto or under KS21i                   |    | A10i-TILT        |  |
| Fastening bracket with angles for A10i                                      |    | A10i-TILTBRACKET |  |
| Fastening bracket for A15i  |   | Ai-FIXBRACKET    |  |
| Clamp certified for 250 kg  |  | CLAMP250         |  |
| Magnetic plate for laser inclinometer (compatible with TEQSAS LAP-TEQ PLUS) |  | LASER-MAGPLATE   |  |
| Flying frame for vertical deployment of A15 and KS21                        |  | A15-BUMP         |  |
| Extension bar for rigging frame   |  | M-BAR            |  |
| Rigging element for horizontal deployment of A15                            |  | A15-LIFT         |  |

|   |   |                        |                   |
|---|---|------------------------|-------------------|
| Rigging bar and pullback for A15 and KS21                                   |     | A15-RIGBAR             |                   |
| Pole mount for A15 and A10  |     | A-MOUNT                |                   |
| Rigging element for stacking A15 and A10 onto KS21                          |     | A-TILT                 |                   |
| Rigging bar for 1 enclosure   |     | X-BAR                  |                   |
| Clamp certified for 250 kg  |    | CLAMP250               |                   |
| m chain sling with two-leg bridles rated 1 2 tons                           |  | LA-SLING2T             |                   |
| Magnetic plate for laser inclinometer (compatible with TEQSAS LAP-TEQ PLUS) |   | LASER-MAGPLATE         |                   |
| Acoustically transparent front screen for A15i Focus                        |   | A15i FOCUS-SCREEN      | A15i Focus / Wide |
| Acoustically transparent front screen for A15i Focus with A15i-LIFT         |   | A15i FOCUS-SCREEN-LIFT |                   |
| Acoustically transparent front screen for A15i Wide                         |   | A15i WIDE-SCREEN       |                   |

|   |  |                              |  |
|---|--|------------------------------|--|
| <p>Acoustically transparent front screen for A15i Wide with A15i-LIFT</p> |    | <p>A15i WIDE-SCREEN-LIFT</p> |  |
| <p>Flying frame for vertical deployment of A15i and KS21i</p>             |    | <p>A15i-BUMP</p>             |  |
| <p>Extension Bar for rigging frame (Installation version)</p>             |    | <p>M-BARi</p>                |  |
| <p>Rigging element for horizontal deployment of A15i</p>                  |    | <p>A15i-LIFT</p>             |  |
| <p>Rigging bar and pullback for A15i and KS21i</p>                        |   | <p>A15i-RIGBAR</p>           |  |
| <p>U-bracket for A15i and KS21i</p>                                       |  | <p>A-U15i</p>                |  |
| <p>Rigging element with angles for A15i above or under KS21i</p>          |  | <p>A15i-TILT</p>             |  |
| <p>Fastening bracket with angles for A15i</p>                             |  | <p>A15i-TILTBRACKET</p>      |  |
| <p>Fastening bracket for A15i</p>   |  | <p>Ai-FIXBRACKET</p>         |  |
| <p>Clamp certified for 250 kg</p>   |  | <p>CLAMP250</p>              |  |

Magnetic plate for laser inclinometer  
(compatible with TEQSAS LAP-TEQ PLUS)



LASER-  
MAGPLATE

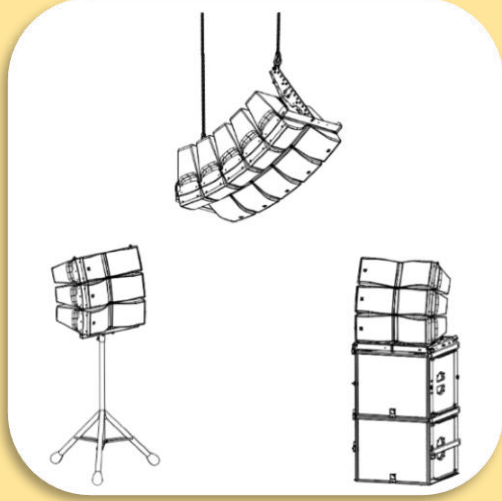





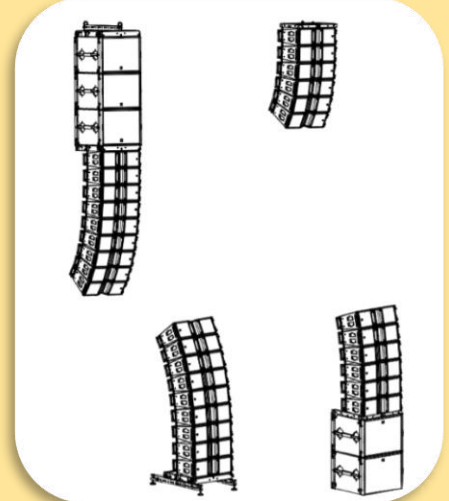









**KIRA**









**K SERIES**

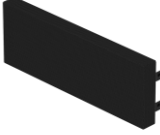





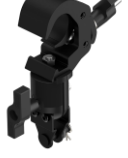













**KARA**

| תיאור   | תמונה  | סטנדים ואביזרים   | דגם<br>הרמקול |
|---|--|-------------------|---------------|
| Rigging frame for flying or stacking KIVA II/KIVA and SB15m       |  | KIBU-SB           | KIVA II       |
| Rigging frame for flying KIVA II/KIVA                             |  | KIBU II           |               |
| Rigging plate for ceiling or pole-mount of 3 KIVA II/KIVA maximum |  | KIET II           |               |
| Pullback accessory for KIVA II/KIVA                               |  | KIVA-<br>PULLBACK |               |
| Clamp certified for 250 kg  |  | CLAMP250          |               |





|   |  |                    |            |
|---|--|--------------------|------------|
| Magnetic plate for laser inclinometer<br>(compatible with TEQSAS LAP-TEQ PLUS)  |    | LASER-<br>MAGPLATE | KARA<br>II |
| Bumper for flying or stacking KARA<br>(II)/SB18                                 |    | M-BUMP             |            |
| Extension bar for rigging frame   |    | M-BAR              |            |
| Mini bumper for flying 6 KARA (II)  |    | KARA-<br>MINIBU    |            |
| Extension bars for flying/stacking<br>SB18/KARA (II)                            |   | KARA-<br>MINIBUEX  |            |
| Pullback plate for KARA (II)  |  | KARA-<br>PULLBACK  |            |
| tilt adjustment screw jacks with 2 angle 4<br>bar extensions for stacked M-BUMP |  | M-JACK             |            |
| angle bar extension for KARA (II) 2<br>bumper                                   |  | KARA-<br>ANGARMEX  |            |
| Clamp certified for 250 kg  |  | CLAMP250           |            |
| Magnetic plate for laser inclinometer<br>(compatible with TEQSAS LAP-TEQ PLUS)  |  | LASER-<br>MAGPLATE |            |

|   |  |                     |          |
|---|--|---------------------|----------|
| Acoustically transparent front screen for KARA Ili                          |    | KARAIli-SCREEN      | KARA Ili |
| Flying frame for vertical deployment of KARA Ili and SB18 Ili               |    | KARAIli-BUMP        |          |
| Extension Bar for rigging frame (Installation version)                      |    | M-BARi              |          |
| Rigging bar and pullback for KARA Ili and SB18 Ili                          |    | KARAIli-RIGBAR      |          |
| Rigging element with angles for KARA Ili above or under SB18 Ili            |   | KARAIli-TILT        |          |
| Fastening bracket with angles for KARA Ili                                  |  | KARAIli-TILTBRACKET |          |
| Fastening bracket for KARA Ili and SB18 Ili                                 |  | KARAIli-FIXBRACKET  |          |
| Clamp certified for 250 kg  |  | CLAMP250            |          |
| Magnetic plate for laser inclinometer (compatible with TEQSAS LAP-TEQ PLUS) |  | LASER-MAGPLATE      |          |
| Flying frame for K3 (incl. 1 BPCHAIN 1.5T)                                  |  | K3-BUMP             | K3       |

|   |   |              |
|---|---|--------------|
| Extension bar for K3-BUMP                             |     | K3-BAR       |
| Rigging bar and pullback for K3 (includes LA-SLING2T) |     | K3-RIGBAR    |
| Rigging element for stacking K3 on KS28               |     | K3-TILT      |
| Mounting cradles for 1 LA-RAK                         |     | LA-RAKMOUNT  |
| Azimuth angle tuning accessory 1.5T                   |    | DELTA 1.5T   |
| Extension sling 1.5 tons                              |  | BPCHAIN 1.5T |
| m chain sling with two-leg bridles rated 1 2 tons     |  | LA-SLING2T   |
| Interface for flying Kara (II) below K3               |   | KARA-DOWNK3  |
| Chariot for up to 4 K3                                |   | K3-CHARIOT   |
| tilt adjustment screw jacks + bar for K2- 4 CHARIOT   |   | K2-JACK      |



|  |  |                            |     |
|--|--|----------------------------|-----|
| Magnetic plate for laser inclinometer<br>(compatible with TEQSAS LAP-TEQ PLUS) |    | LASER-<br>MAGPLATE         | K3i |
| Acoustically transparent front screen for<br>K3i                               |    | K3i-SCREEN                 |     |
| Flying frame for K3i   |    | K3i-BUMP                   |     |
| Extension bar for K3i-BUMP   |    | K3i-BAR                    |     |
| Rigging bar and pullback for K3i   |   | K3i-RIGBAR                 |     |
| Fastening bracket with angles for K3i  |  | K3i-<br>TILTBRACKET        |     |
| Ceiling fastening bracket with angles for<br>K3i                               |  | K3i-<br>CEILINGBRAC<br>KET |     |
| Interface for flying Kara Ili under K3i  |  | KARAlli-<br>DOWNK3i        |     |
| Magnetic plate for laser inclinometer<br>(compatible with TEQSAS LAP-TEQ PLUS) |  | LASER-<br>MAGPLATE         |     |





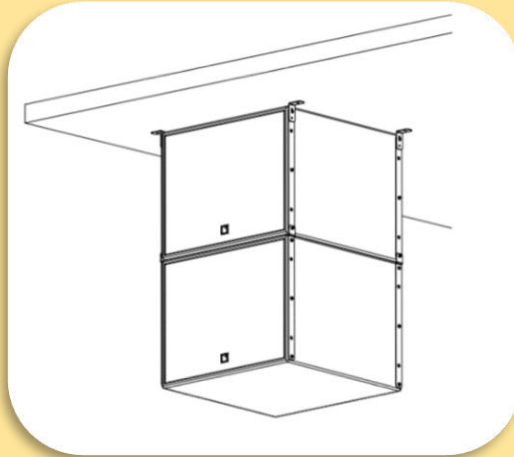
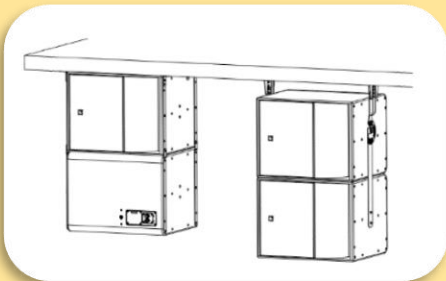

















|  |   |             |       |
|--|---|-------------|-------|
| Structure for flying & stacking K1 and K1-SB arrays          |   | K1-BUMP     | K1-SB |
| Rigging accessory for rear attachment of 2 motors to K1-BUMP |   | K1-DELTA    |       |
| Extension sling for K1 and K2                                |  | K1-BPCHAIN  |       |
| Interface for flying Kara (II) below K1                      |   | KARA-DOWNK1 |       |
| Rigging accessory for rear attachment of K2 below K1         |  | K2-LINK     |       |







## SUBWOOFERS



| תיאור   | תמונה  | סטנדים ואביזרים    | דגם הרמקול |
|---|--|--------------------|------------|
| On-wall mounting accessory with silent blocks for SB10i     |  | SB10i-WALLMOUNT NT | SB10i      |
| Rigging frame for flying or stacking KIVA II/KIVA and SB15m |  | KIBU-SB            | SB15m      |

|  |  |                |          |
|--|--|----------------|----------|
| Clamp certified for 250 kg                                       |    | CLAMP250       | SB18     |
| Bumper for flying or stacking KARA (II)/SB18                     |    | M-BUMP         |          |
| Mini bumper for flying 6 KARA (II)                               |    | KARA-MINIBU    |          |
| Extension bars for flying/stacking SB18/KARA (II)                |    | KARA-MINIBUEX  |          |
| Clamp certified for 250 kg                                       |   | CLAMP250       |          |
| Acoustically transparent front screen for SB18 Ili               |  | SB18Ili-SCREEN | SB18 Ili |
| Flying frame for vertical deployment of KARA Ili and SB18 Ili    |  | KARAIli-BUMP   |          |
| Extension Bar for rigging frame (Installation version)           |  | M-BARi         |          |
| Rigging bar and pullback for KARA Ili and SB18 Ili               |  | KARAIli-RIGBAR |          |
| Rigging element with angles for KARA Ili above or under SB18 Ili |  | KARAIli-TILT   |          |

|  |  |                    |       |
|--|--|--------------------|-------|
| Fastening bracket for KARA Ili and SB18 Ili            |    | KARAIli-FIXBRACKET |       |
| Clamp certified for 250 kg                             |    | CLAMP250           |       |
| Flying frame for vertical deployment of A15 and KS21   |    | A15-BUMP           |       |
| Rigging bar and pullback for A15 and KS21              |    | A15-RIGBAR         | KS21  |
| Stability bars for KS21                                |   | KS21-OUTRIG        |       |
| tilt adjustment screw jacks + bar for K2- 4 CHARIOT    |  | K2-JACK            |       |
| Clamp certified for 250 kg                             |  | CLAMP250           |       |
| Acoustically transparent front screen for KS21i        |  | KS21i-SCREEN       | KS21i |
| Flying frame for vertical deployment of A15i and KS21i |  | A15i-BUMP          |       |
| Rigging bar and pullback for A15i and KS21i            |  | A15i-RIGBAR        |       |

|   |  |               |  |
|---|--|---------------|--|
| U-bracket for A15i and KS21i                              |    | A-U15i        |  |
| Rigging element with angles for A15i above or under KS21i |    | A15i-TILT     |  |
| Rigging elements with angles for A10i onto or under KS21i |    | A10i-TILT     |  |
| Fastening bracket for A15i                                |    | Ai-FIXBRACKET |  |
| Clamp certified for 250 kg                                |   | CLAMP250      |  |
| Lifting beam for flying up to 16 x KS28                   |  | KS28-BUMP     |  |
| Stability bars for KS28                                   |  | KS28-OUTRIG   |  |